



**Assembly and Operating Instructions for Outback®
Excel 200, and Excel 300 Gas Barbecues**



EX200T



EX300T

Photographs are not to scale.
Specifications subject to change
without prior notice.



WARNING

- For outdoor use only. Not for commercial use.
- Read instructions before using the appliance. Failure to follow instructions could result in death, serious bodily injury, and/or property loss.
- Warning: accessible parts may be very hot. Keep young children and pets away.
- Do not move the appliance during use.
- Turn off the gas supply at the gas bottle after use.
- Any modification of the appliance, misuse, or failure to follow the instructions may be dangerous and will invalidate your warranty. This does not affect your statutory rights.
- Retain these instructions for future reference.
- Leak test annually, and whenever the gas bottle is removed or replaced. Check that the hose connections are tight and leak test each time you reconnect the gas bottle.
- For Flare-up control please refer to the 'OPERATION' section of this manual.

FOR YOUR SAFETY

If you smell gas:

1. Shut off gas to the appliance.
2. Extinguish any open flame.
3. Open barbecue lid or hood.
4. If odour continues, discontinue use and contact your local dealer.

FOR YOUR SAFETY

1. Do not store or use petrol or other flammable vapours or liquids in the vicinity of this or any other appliance.
2. A gas bottle not connected for use must not be stored in the vicinity of this or any other appliance.

Parts List

Quantity varies according to model purchased. Specifications subject to change without prior notice. For more details on hardware, please see the corresponding 'Hardware Reference Diagram'.

	CODE	PART	QTY	OUTBACK® EXCEL 200 GAS	OUTBACK® EXCEL 300 GAS
HOOD	A1	Hood (<i>Pre-Assembled to Body</i>)	1	√+	√+
	A2	Hood Handle	1	√	√
	A3	Warming Rack	1	√	√
BODY	B1	Barbecue Body	1	√+	√+
	B2	Burner	1	√	√
	B3	Control Panel	1	√	√
	B4	Knob (<i>Pre-Assembled</i>)	2	√+	√+
	B5	Hose and Regulator Assembly	1	√+	√+
	B6	Lava Rock in Basket	1	√+	√+
	B7	Cooking Grill	1	√	√
	B8	Ignition Button (<i>Pre-Assembled</i>)	1	√+	√+
	B9	Control Panel Heat Shield	1	√+	√+
	B10	Main Electrode	1	√	√
	B11	Hinge Bracket (<i>Pre-Assembled</i>)	2	√+	√+
	B12	Body Heat Shield	1	√	√
	B13	Body Support	2	√	√
	B14	Grease Cup Holder	1	√	√
	B15	Grease Cup	1	√	√
TROLLEY	C1	Side Shelf (with bracket)	★	1	
	C2	Side Shelf (without bracket)	1	√	√
	C3	Side Shelf Bracket A	1	√	√
	C4	Side Shelf Bracket B	1	√	√
	C5	Side Burner Knob	★		1
	C6	Side Burner Grid	★		1
	C7	Side Burner Shelf	★		1
	C8	Side Burner	★		1
	C9	Side Burner Electrode	★		1
	C10	Side Burner Valve / Hose Assembly	★		1
	C11	Left Front Leg	1	√	√
	C12	Left Rear Leg	1	√	√
	C13	Right Front Leg	1	√	√
	C14	Right Rear Leg	1	√	√
	C15	Hose Tidy	1	√	√
	C16	Gas Bottle Holder	1	√	√
	C17	Leg End Loop	1	√	√
	C18	Wheel Spacer	2	√	√
	C19	Wheel	2	√	√
	C20	Axle	1	√	√
	C21	Bottom Shelf	1	√	√
	C22	Gas Bottle Strap	1	√+	√+
HARDWARE	D1	M6x15 Bolt	28	√	√
	D2	M5x10 Bolt	4	√	√
	D3	M4x10 Bolt	★		1
	D4	ST4.0x10 Screw	7	√	√
	D5	ST4.0x15 Screw	4	√	√
	D6	ST4.8x15 Screw	2	√	√
	D7	M8 Locknut	2	√	√
	D8	M5 Nut	2	√	√
	D9	Spacer	★	10	6

✚ Pre-Assembled Component

★ Quantity varies according to model purchased

▲ Appearance, size, and construction may differ according to model purchased

Parts Diagram: Excel 200

Quantity varies according to model purchased. Specifications subject to change without prior notice. For more details on hardware, please see the corresponding 'Hardware Reference Diagram'.

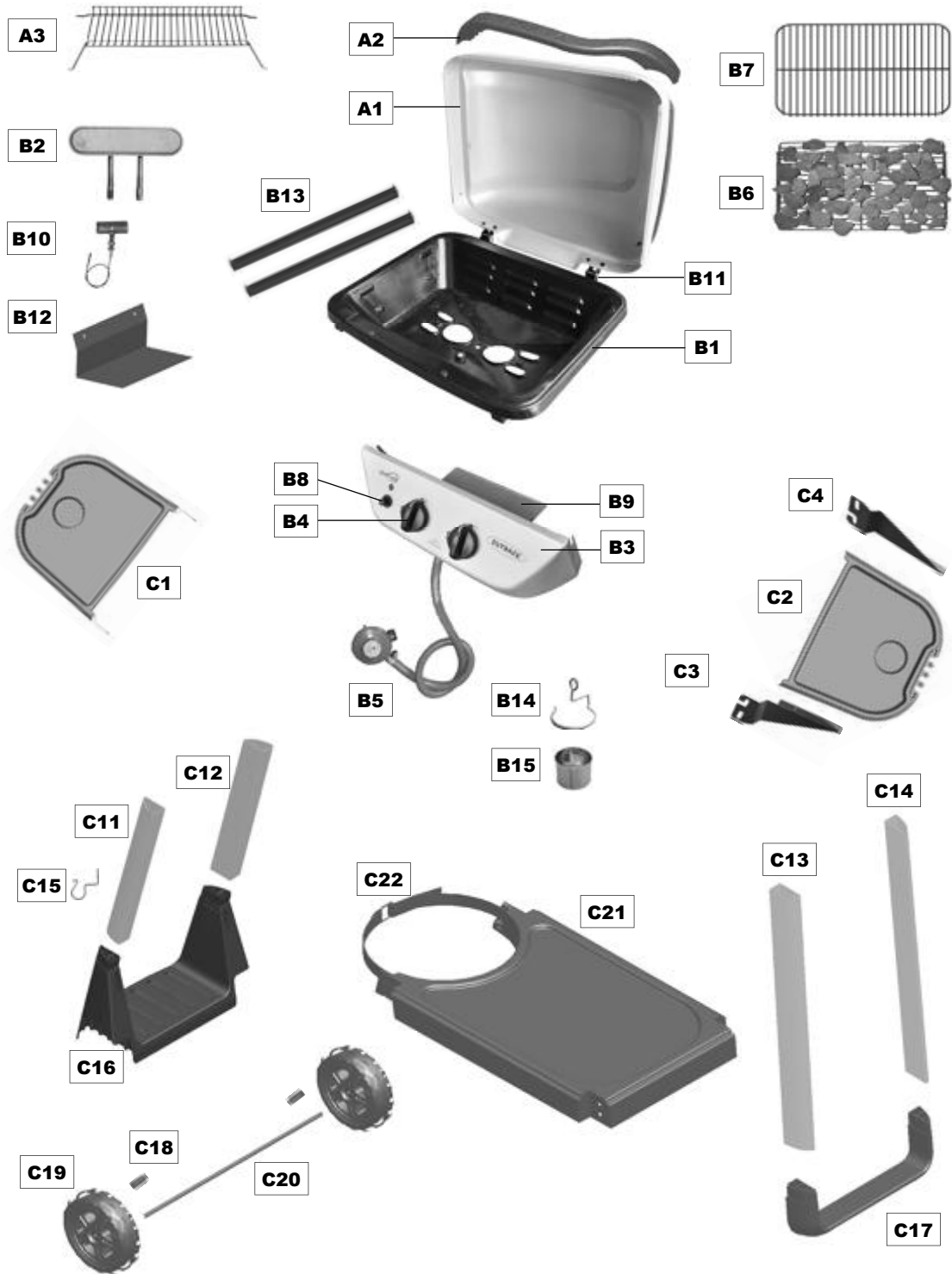

Hardware Reference Diagram: Excel 200

Specifications subject to change without prior notice.

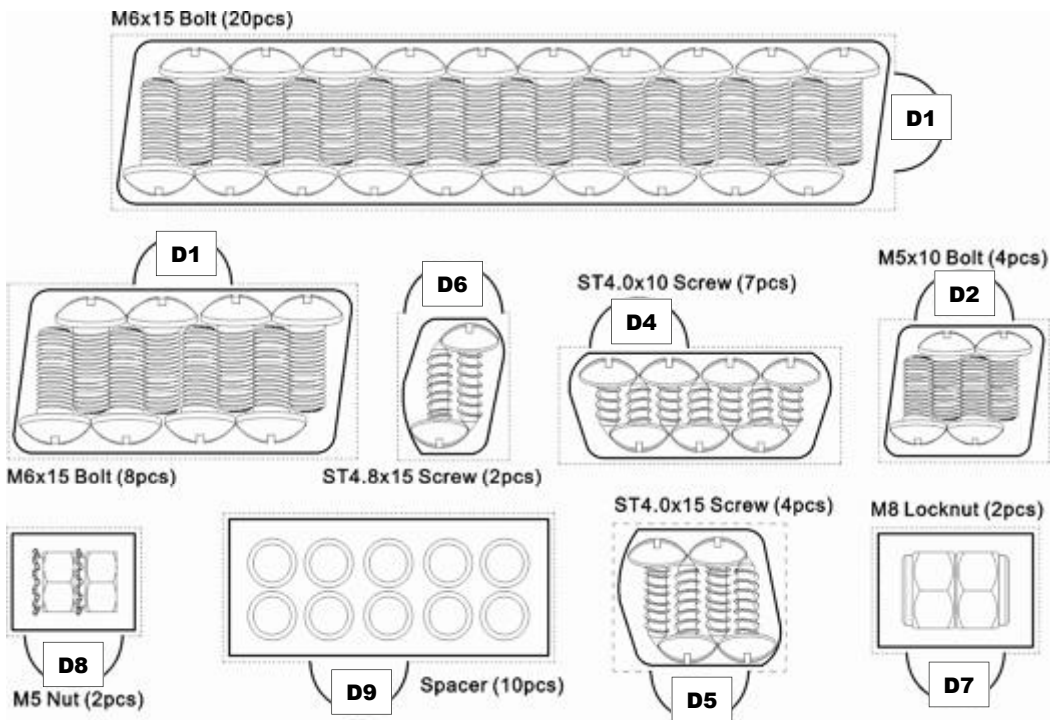

Parts Diagram: Excel 300

Quantity varies according to model purchased. Specifications subject to change without prior notice. For more details on hardware, please see the corresponding 'Hardware Reference Diagram'.



Hardware Reference Diagram: Excel 300

Specifications subject to change without prior notice.

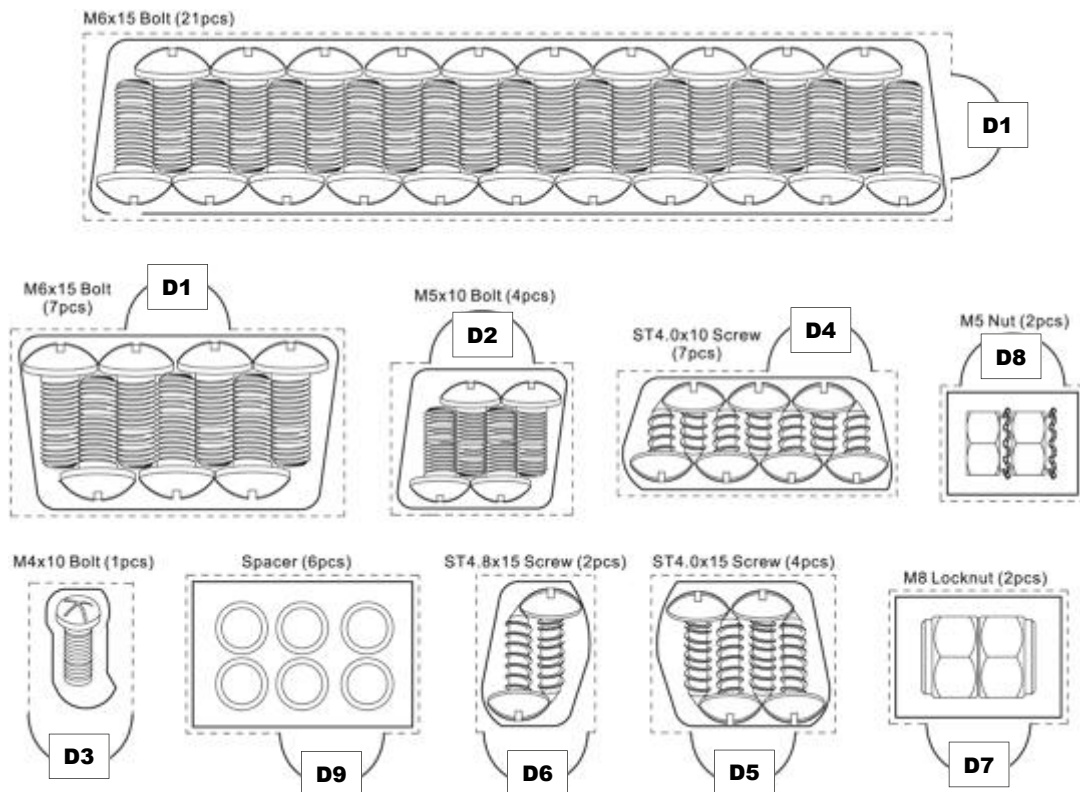

Assembly

IMPORTANT!

- **TOOLS NEEDED FOR ASSEMBLY:** Medium size flat blade or Phillips/Crosspoint screwdriver, adjustable spanner or metric spanner set.
- The assembly of this barbecue requires 2 people.
- Whilst every care is taken in the manufacture of this product, care must be taken during assembly in case sharp edges are present.
- **Please read the Important Information section carefully before assembly and use of your barbecue.**

1

✓ Excel 200

✓ Excel 300

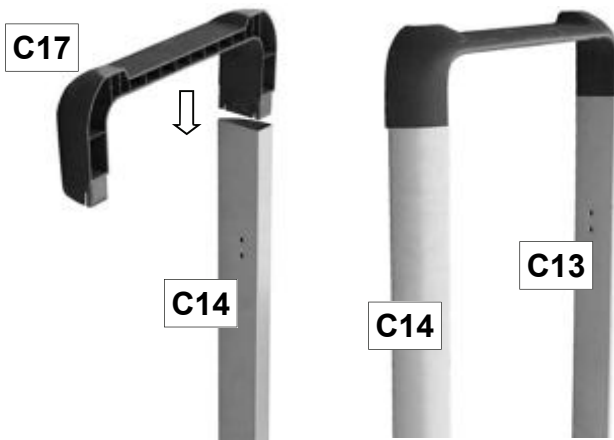

Attach the Right Front Leg (C13) and Right Rear Leg (C14) to the Leg End Loop (C17). The legs are a push fit onto the leg end loop. In case of difficulty, they may need tapping with a soft faced mallet. Take care not to damage the parts.

2

✓ Excel 200

✓ Excel 300

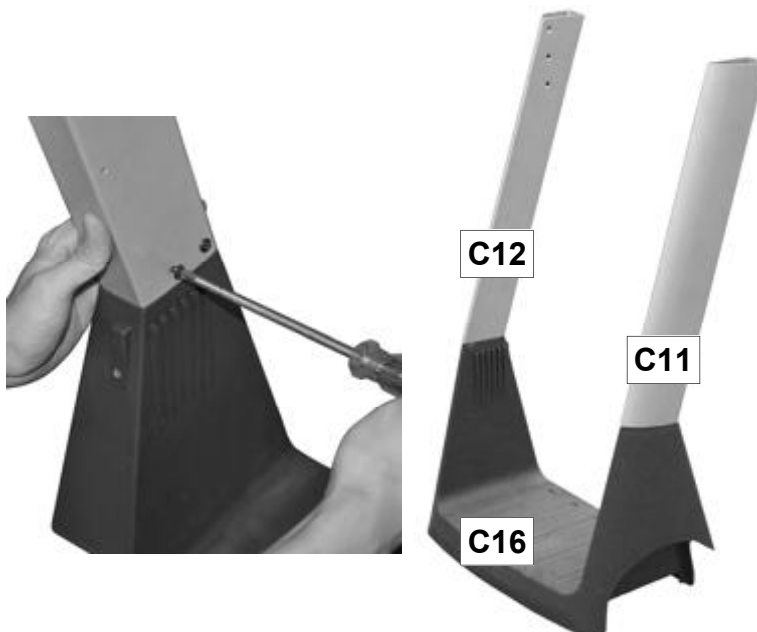

Attach the Left Front Leg (C11) and Left Rear Leg (C12) to the Gas Bottle Holder (C16) using ST4.0x10 Screws(D4).

3

✓ Excel 200

✓ Excel 300

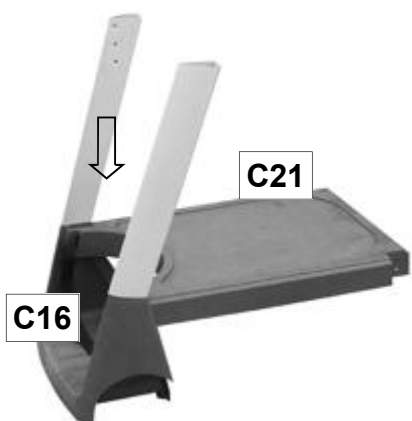

Attach the Bottom Shelf (C21) to the Gas Bottle Holder (C16) using ST4.8x15 Screws (D6). Take care not to over tighten these screws which will damage the plastic gas bottle holder.

Note: This step assembly requires 2 people.

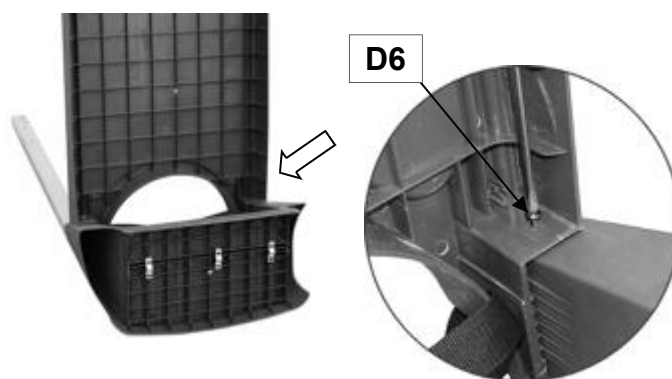
**4**

✓ Excel 200

✓ Excel 300

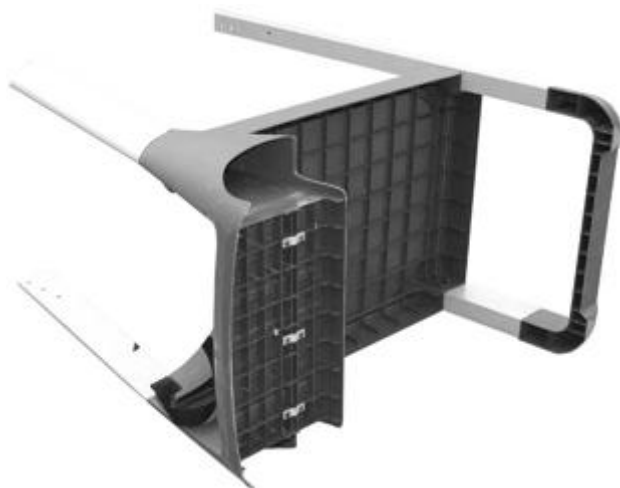

Attach the leg assembly to the bottom shelf assembly using M6x15 Bolts (D1).

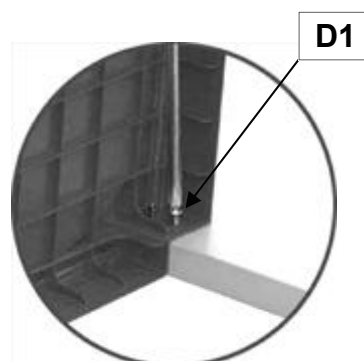

5

✓ Excel 200 ✓ Excel 300

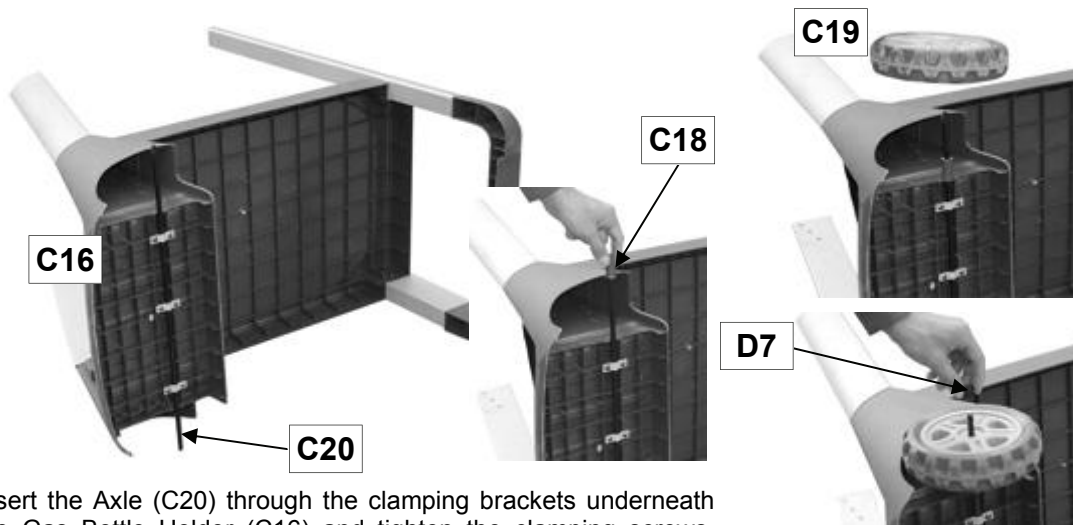

Insert the Axle (C20) through the clamping brackets underneath the Gas Bottle Holder (C16) and tighten the clamping screws. Take care not to over tighten these screws which will damage the plastic gas bottle holder.

Slide a Wheel Spacer (C18) over each end of the Axle (C20). Note: the spacers are packed in a plastic bag with the main electrode, grease cup holder and grease cup.

Slide the Wheels (C19) over each end of the axle. Secure the wheels into place with the M8 Locknuts (D7).

6

✓ Excel 200 ✓ Excel 300

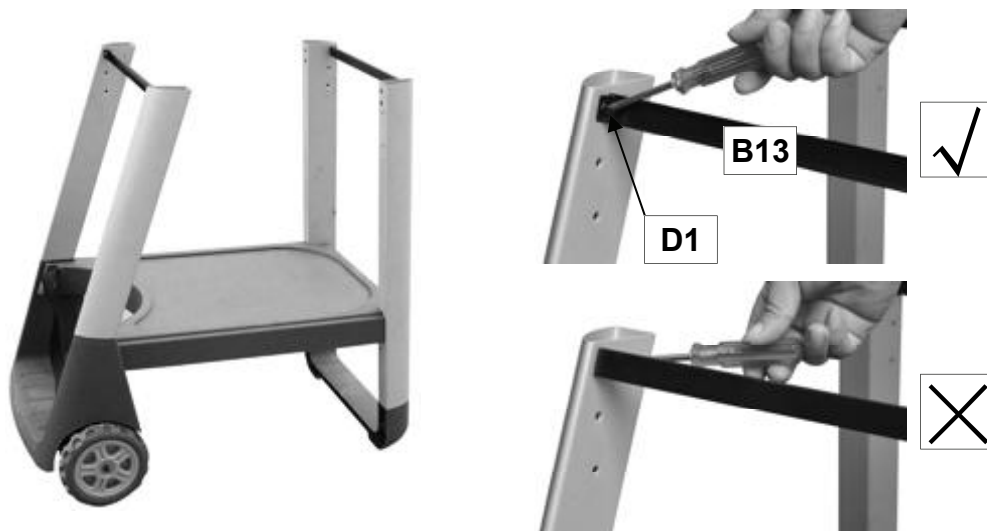

Carefully turn the completed trolley over, right side up.

Attach the Body Support (B13) to the legs using M6x15 Bolts (D1).

7

✓ Excel 200 ✓ Excel 300



Attach the Hood Handle (A2) to the Hood (A1) using the M5x10 Bolts (D2).

8

✓ Excel 200 ✓ Excel 300

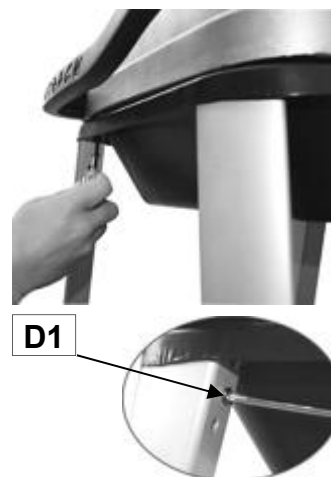
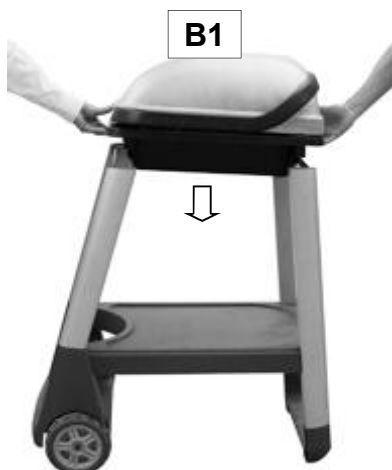

Carefully place the Barbecue Body (B1) onto the tops of the legs.

Attach the barbecue body to the trolley assembly using the M6x15 Bolts (D1). Ensure the tabs on the body fit over the legs as shown in the diagram and do not go down inside of the legs.

WARNING: DO NOT RELEASE THE BARBECUE BODY WHILE THE BARBECUE HAS NOT BEEN PROPERLY SEATED. THIS MAY RESULT IN INJURY OR DAMAGE TO YOUR BARBECUE.

9

✓ Excel 200 ✓ Excel 300



Install a M6x15 Bolt (D1) and a Spacer (D9) into the upper fixing hole on each front leg. Place the Control Panel (B3) assembly in position by aligning the spacers with the slot on each side of control panel and fix it to the trolley assembly using M6x15 Bolts (D1).

10

✓ Excel 200 ✓ Excel 300



Feed the Grease Cup Holder (B14) through the hole in barbecue body.



Insert the Grease Cup (B15) into the grease cup holder.

11

✓ Excel 200 ✓ Excel 300



Insert the Main Electrode (B10) into the hole at the bottom of the barbecue body and secure with the pre-assembled nut.

12

✓ Excel 200 ✓ Excel 300

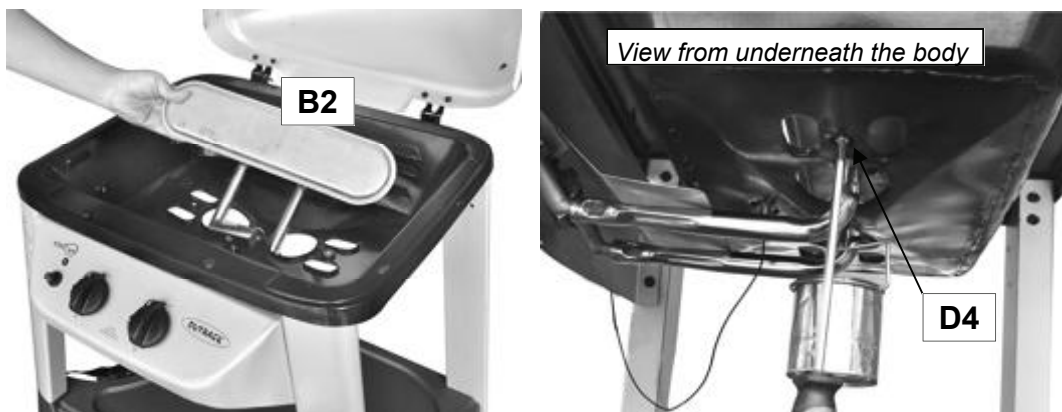

Feed the Burner (B2) into barbecue body. Ensure that the burner venturi tubes are over the ends of the gas valves. They are a loose fit and not a gas tight seal. Secure the burner with the ST4.0x10 Screws (D4).

13

✓ Excel 200 ✓ Excel 300



Attach the Body Heat Shield (B12) to barbecue body using the M5x10 Bolts (D2) and M5 Nuts (D8).

14

✓ Excel 200 ✓ Excel 300



Carefully lay the Lava Rock (B6) into the barbecue body ensuring it lies level within the body. Lay the Cooking Grill (B7) into place.

15

✓ Excel 200 ✓ Excel 300

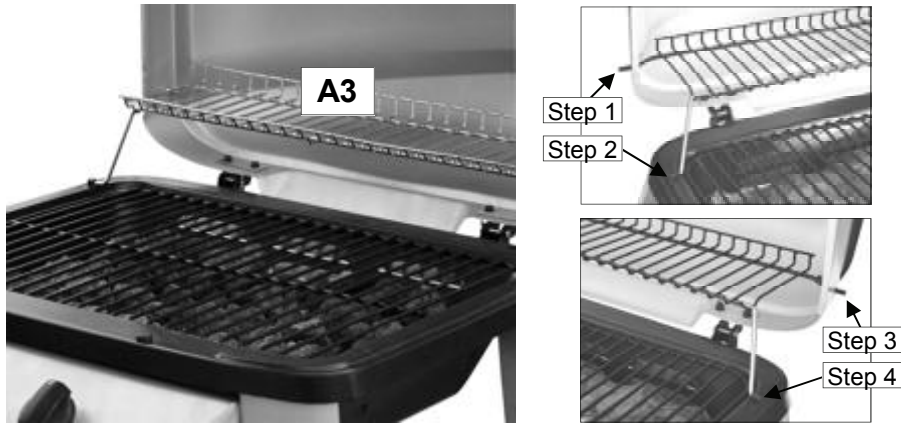

Attach the Warming Rack (A3), to the hood and barbecue body as shown. Make sure that the shorter, fixed legs go through the holes in the hood, then the swing legs fix to the body of the barbecue.

16

✓ Excel 200 ✓ Excel 300

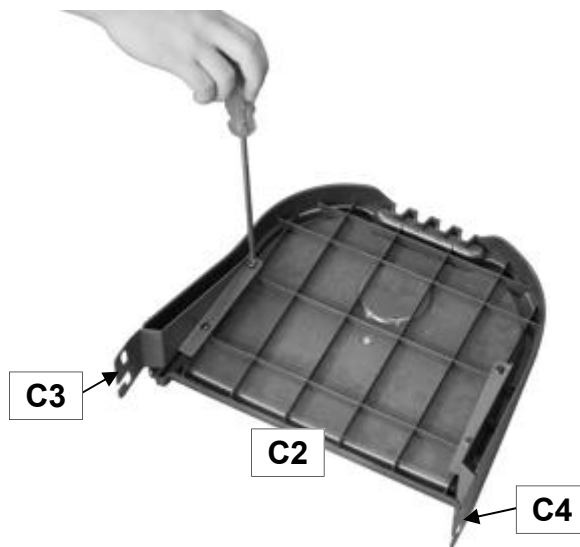

Attach the Side Shelf Bracket A (C3) and Side Shelf Bracket B (C4) to the Side Shelf (C2) using ST4.0x15 Screws (D5).

17

✓ Excel 200 ✓ Excel 300

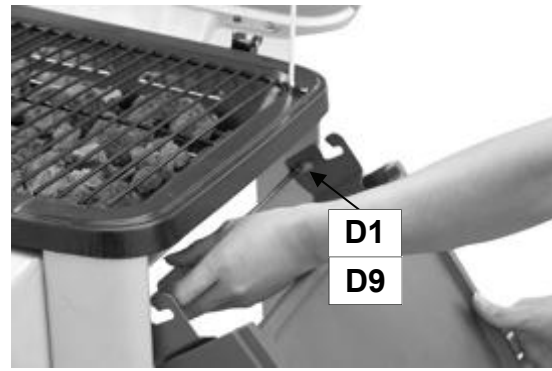
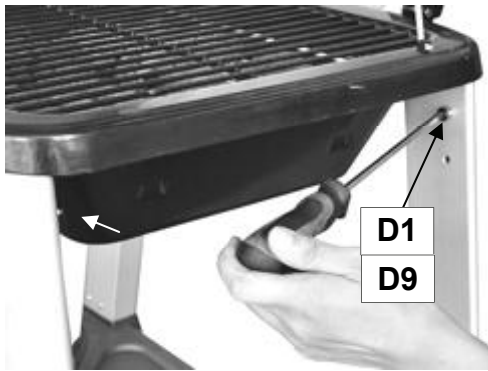

Slide a Shelf Spacer (D9) onto a M6x15 Bolt (D1) and screw it into the upper fixing point on the rear legs as shown. Repeat for the front leg. Attach the assembled Side Shelf (C2) to the right hand side of the barbecue by sliding a Shelf Spacer (D9) onto a M6x15 Bolt (D1) and fitting the shelf to the lower fixing point on the rear leg as shown. Repeat for the front leg.

Hook the shelf onto the upper pins to extend it to its normal horizontal position.

18

✓ Excel 200 ✗ Excel 300

Excel 300 users, skip this step and proceed directly to step 19.

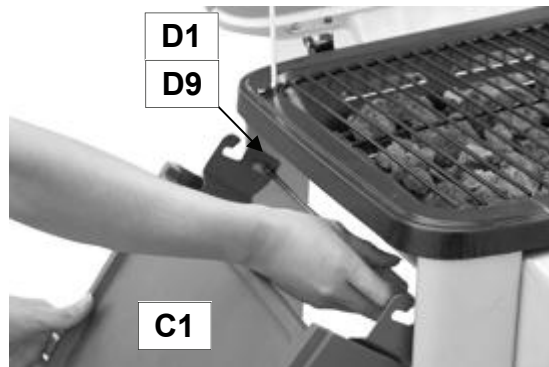
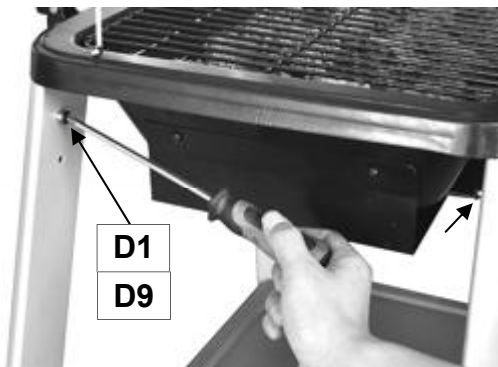

Slide a Shelf Spacer (D9) onto a M6x15 Bolt (D1) and screw it into the upper fixing point on the rear legs as shown. Repeat for the front leg. Attach the previously assembled Side Shelf (C1) to the left hand side of the barbecue by sliding a Shelf Spacer (D9) onto a M6x15 Bolt (D1) and fitting the shelf to the lower fixing point on the rear leg as shown. Repeat for the front leg.

Hook the shelf onto the upper pins to extend it to its normal horizontal position.

19

X Excel 200 **✓** Excel 300

Excel 200 users, skip this step and proceed directly to step 23.

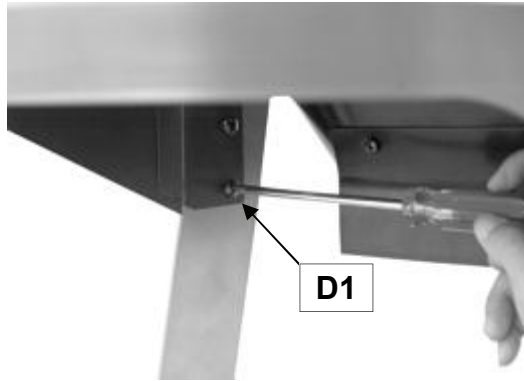
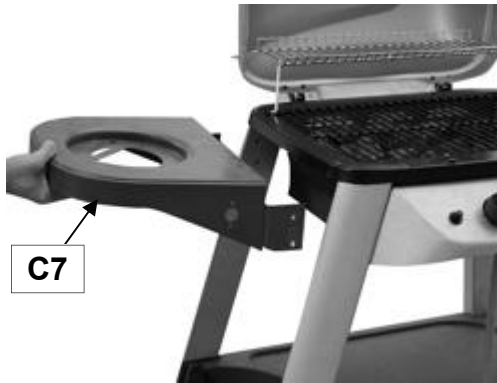

Attach the Side Burner Shelf (C7) to the left front and left rear legs using M6x15 Bolts (D1).

20

X Excel 200 **✓** Excel 300



Remove the screws from Side Burner Valve / Hose Assembly (C10) and secure it to the side shelf with those 2 screws.

Assemble the Side Burner Knob (C5) onto the side burner valve.

21

✗ Excel 200

✓ Excel 300

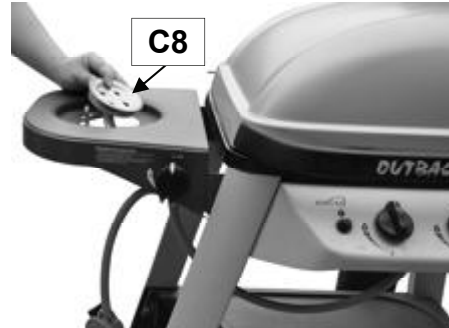
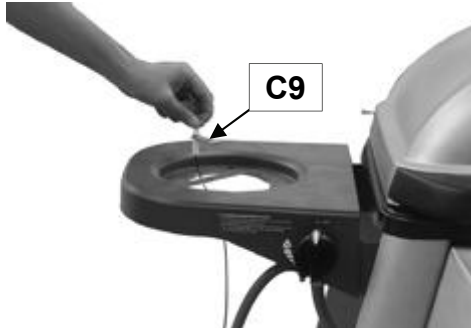

Place the Side Burner Electrode (C9) onto the side burner shelf as shown. Place the Side Burner (C8) through the central hole. Fit the side burner venturi tube over the gas valve outlet. This is a loose fit and not a gas tight seal. Secure the electrode and burner with M4x10 Bolt (D3).

**22**

✗ Excel 200

✓ Excel 300

Connect the electrode wire to the Ignition Button (B8) under the control panel.

Place the Side Burner Grid (C6) onto the side burner shelf.

**B8**

Side burner electrode wire goes here.

Main burner electrode wire goes here.

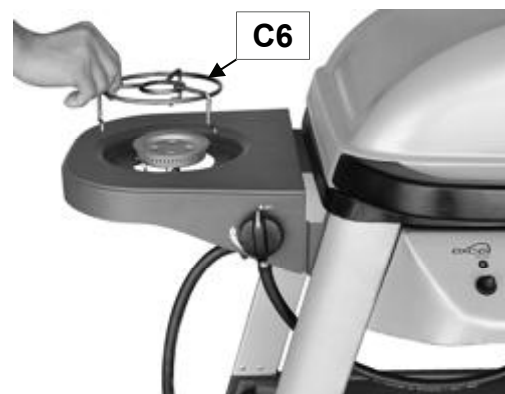
**C6**

NOTE: Make sure the base of cooking utensil to put on the side burner is larger than 150mm and smaller than 220mm.

23

✓ Excel 200 ✗ Excel 300

Excel 300 users, skip this step and proceed directly to step 24.

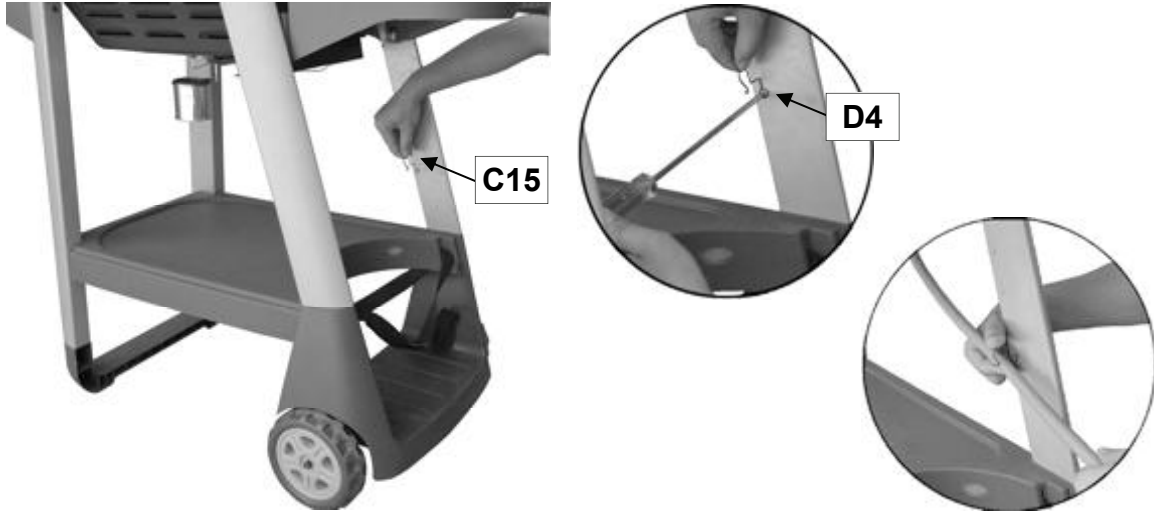

Fix the Hose Clip (C15) into the lower hole of the front short leg using a ST4.0x10 Screw (D4), then feed the hose through the clip as shown.

Important: Regularly check the hose positioning to ensure that it is not in contact with any hot surfaces, such as the bottom of the body or the heat shield.

24

✗ Excel 200 ✓ Excel 300

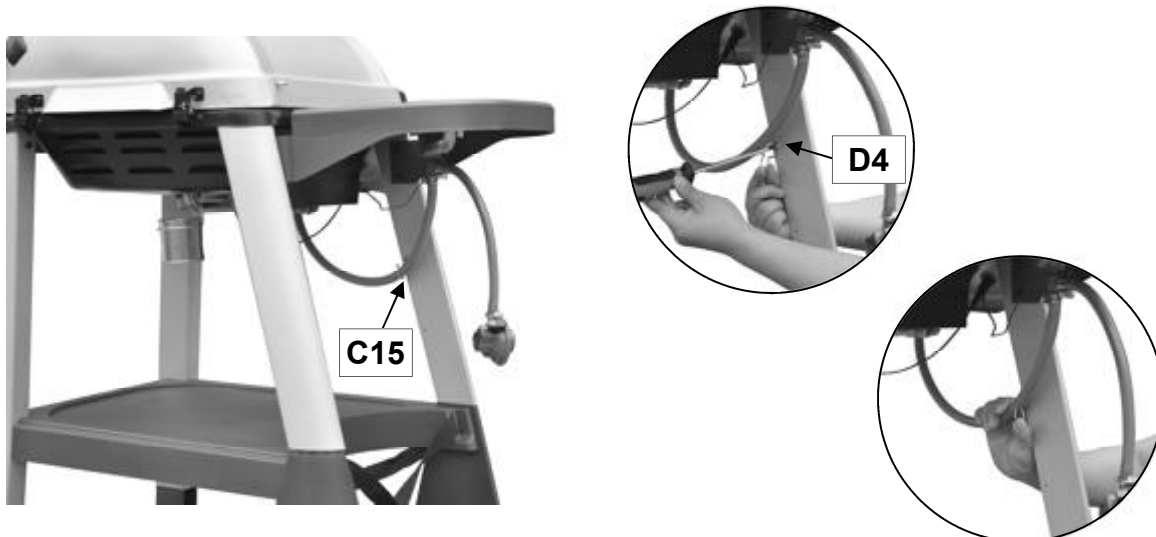

Fix the Hose Clip (C15) into the upper hole of the front short leg using a ST4.0x10 Screw (D4), then feed the hose through the clip as shown.

Important: Regularly check the hose positioning to ensure that it is not in contact with any hot surfaces, such as the bottom of the body or the heat shield.

25

Leak Test Diagram



1. Maximum diameter or breadth is 315mm.
2. Maximum height (regulator included) is 580mm.

**ASSEMBLY IS NOW COMPLETE.
PROCEED TO THE NEXT PAGE FOR INSTRUCTIONS ON OPERATION AND
MAINTENANCE**

ALL JOINTS AND CONNECTIONS MUST NOW BE **LEAK TESTED** BEFORE USING THE BARBECUE.

Leak test annually, and whenever the gas bottle is removed or replaced.

Leak Testing

Always perform a leak test in a well-ventilated area.

Step 1 - Confirm all control knobs are in the off position.

Step 2 - Turn the gas on / open the gas control valve on the gas bottle or regulator.

Step 3 - Check for leaks by brushing a solution of $\frac{1}{2}$ water and $\frac{1}{2}$ liquid detergent / soap over all the gas system joints, including gas bottle valve connections, hose connections, and regulator connections.

Step 4 - NEVER USE AN OPEN FLAME to test for leaks at any time.

Step 5 - If bubbles form over any of the joints there is a leak

- Turn off the gas supply at the gas bottle
- Retighten all joints
- Repeat test
- If bubbles form again do not use the barbecue and contact your local distributor for assistance.

Always wipe the mixed solution ($\frac{1}{2}$ water and $\frac{1}{2}$ liquid detergent / soap) from all joints and connections after leak testing.

Important Information

Please read these instructions carefully before assembly and use of your barbecue.

- ▲ Retain these instructions for future reference.
- ▲ This product is for outdoors use only. Do not use indoors.
- ▲ Do not use the barbecue or store gas bottles below ground level. LP gas is heavier than air so if a leak occurs the gas will collect at a low level and could ignite in the presence of a flame or spark.
- ▲ For use with LPG bottled gas only. A suitable regulator must be used for butane, propane or mixes.
- ▲ Remove plastic wrap from any part before lighting.
- ▲ Do not use within 1m of any flammable structure or surface. Do not use under any combustible surface.
- ▲ LP gas bottles should never be placed directly underneath the barbecue.
- ▲ LP gas bottles should never be stored or used laid on their side, in the horizontal position. A leak would be very serious and liquid could enter the gas line with serious result.
- ▲ Never store gas bottles indoors.
- ▲ Open the barbecue hood or lid before lighting.
- ▲ Once lit, do not move the barbecue until it has completely cooled, after use.
- ▲ This barbecue must not be left unattended when lit.
- ▲ The hood or lid handle can become very hot. Grip only the centre of the handle. Always use oven gloves when cooking or carrying out any adjustments to the barbecue.
- ▲ Use purpose designed barbecue tools with long, heat resistant handles.
- ▲ Use caution when opening the hood or lid, as hot steam inside is released upon opening.
- ▲ Parts of this barbecue become very hot – care must be taken, especially when children, elderly people, and animals are present.
- ▲ Turn off the gas supply at the gas bottle after use.
- ▲ Never cover a barbecue until it has completely cooled.
- ▲ Use this barbecue only on a stable, flat surface.

- ▲ Before you use your barbecue, perform a leak test. This is the only safe and sure way to detect any gas leaking from joints and connections of the barbecue after assembly.
- ▲ Leak test annually, and whenever the gas bottle is removed or replaced.
- ▲ Do not store flammable materials near this barbecue.
- ▲ Do not use aerosols near this barbecue.
- ▲ Failure to follow the manual's instructions could result in serious injury or damage.
- ▲ Parts sealed by the manufacturer or his agent must not be altered by the user.
- ▲ Modification of the barbecue may be dangerous, is not permitted and will nullify any warranty.
- ▲ If you have any queries regarding these instructions, contact your local dealer.

Gas, Regulator and Hose

This barbecue can use either propane or butane or propane / butane mixed LPG (liquid petroleum gas) bottled gas. Propane bottles, will supply gas all year round, even on cold winter days. Butane bottles will supply sufficient gas in summer, but it may affect the performance of the barbecue and restrict the heat output available from the burners, particularly once the gas temperature starts to fall below +10°C. A spanner may be required to change gas bottles.

- The hose should hang freely with no bends, twisting, tension, folds, or kinks that could obstruct free flow of gas. Always inspect the hose for cuts, cracks, or excessive wear before use.
- Apart from the connection point, no part of the hose should touch any hot barbecue parts. If the hose shows any sign of damage it must be replaced with a hose suitable for use with LP gas which meets the national standards for the country of use.
- A suitable hose must comply with EN16436-1 or local regulation, and the length should not exceed 1.5 metres.

For optimal performance, we suggest to use a 13kg propane gas bottle. A suitable regulator must comply with EN16129. **YOU MUST HAVE THE PROPER REGULATOR AND BOTTLE IN ORDER FOR THE BARBECUE TO OPERATE SAFELY AND EFFICIENTLY. USE OF AN**

INCORRECT OR FAULTY REGULATOR IS DANGEROUS AND WILL INVALIDATE ANY WARRANTY. Please consult your local gas dealer for the most suitable gas bottles and regulators.

Installation

Selecting a Location

This barbecue is for **outdoor use only** and should be placed in a well-ventilated area, and on a safe and even surface. Never place your barbecue below ground level. Take care to ensure that it is not placed **UNDER** any combustible surface. The sides of the barbecue should **NEVER** be closer than 1 metre from any combustible surface, including trees and fences and make sure that there are no heat sources near the barbecue (cigarettes, open flames, spark etc.). Keep this barbecue away from any flammable materials!

Precautions

Do not obstruct any ventilation openings in the barbecue body.

Secure the gas bottle on the bottle holder and always tighten it with the black strap provided.

Should you need to install or change the gas bottle, confirm that the barbecue is switched off, and that there are no sources of ignition (cigarettes, open flame, sparks, etc.) near before proceeding.

Connecting a Gas Hose to the Barbecue

Connect the gas hose to the gas rail inlet on the left hand side of the barbecue. Do not overtighten. Do not use any sealing tape, paste or liquid on the connection.

Fixing a Regulator to the Gas Bottle

Confirm all barbecue control knobs are in the off position. Connect the regulator to the gas bottle according to your regulator and bottle dealer's instructions.

Operation

ⓘ Warnings

- ▲ Before proceeding, make certain that you understand the **IMPORTANT INFORMATION** section of this manual.
- ▲ Your barbecue is not designed to be used with more than 50% of the cooking area as

a solid plate — this includes baking dishes. Full coverage will cause excessive build-up of heat and damage the barbecue. This is not covered by warranty.

Preparation Before Cooking

To prevent foods from sticking to the cooking surface, please use a long handled brush to **apply a light coat of cooking or vegetable oil before each barbecuing session.** (Note: When cooking for the first time, paint colours may change slightly as a result. This is normal and should be expected.)

Lighting the Barbecue

- Open the barbecue hood or lid before lighting. **Never** light your barbecue with the hood or lid closed.
- Ensure all knobs are in the off position. Open the gas control valve on the gas bottle or regulator.
- Push and turn the leftmost control knob to the high position. Press the ignition button rapidly several times until left portion of the burner is lit.
- If burner fails to ignite after following above procedure, turn all the knobs to the off position. Close the gas valve on the gas bottle. Wait 5 minutes. Reattempt all of the above steps. If the barbecue still fails to light, please refer to the manual ignition instructions below.
- After successful lighting of the left side, turn the rightmost control knob to the high position. The remaining portion of the burner should ignite automatically.
- After ignition, turn the burners to the low position for 3-5 minutes in order to pre-heat the barbecue. This should be done before each cooking session. The hood or lid must be open during preheating.
- Keep the burner controls on the low position for best cooking results.

Manual Ignition Instructions

- Open the barbecue hood or lid before lighting. **Never** light your barbecue with the hood or lid closed.
- Ensure all knobs are in the off position. Open the gas control valve on the gas bottle or regulator.
- Insert lit match through the right match-lighting hole on the underside of the barbecue body and place near rightmost burner porthole.
- Push and turn the rightmost control knob

anti-clockwise to the high position, taking care to protect yourself from the flames.

- After the right portion of the burner is lit, light the remaining portion of the burner.
- If burner fails to ignite, contact your local dealer for assistance.
- After ignition, turn the burners to the low position for 3-5 minutes in order to pre-heat the barbecue. This should be done before each cooking session. The hood or lid must be open during preheating.
- Keep the burner controls on the low position for best cooking results.

Lighting the Side Burner (Excel 300)

Push and turn the side burner control knob anti-clockwise to the high position. Push the ignitor button rapidly until the side burner ignites. If the side burner fails to ignite, turn the control knob to the OFF position and wait five minutes before attempting to re-light following the above procedure. If the side burner still fails to ignite, turn the control knob off, wait five minutes and light with match.

When using the side-burner, care should be taken to ensure that pans are central and flat on the side-burner grid.

Grill Cooking

The burners heat up the lava rock underneath the grill, which in turn heats the food on the grill. The natural food juices produced during cooking fall onto the hot lava rock below and vaporise. The subsequent rising smoke bastes the food, as it travels upwards, imparting that unique barbecued flavour.

Do not roast food with the hood closed. Closing the hood for prolonged periods of time can lead to overheating of the barbecue or fat fires, which will damage the barbecue.

Warming Rack (where supplied)

Warming racks are a convenient way to keep cooked food warm or to warm items such as bread rolls. It is advisable to place food (particularly fatty foods) to the front of the warming rack to avoid the possibility of juices and fat running down the back of your barbecue. Always check that your warming rack is properly fitted before use.

Flare-Up Control *Very Important Notice*

Flare-ups occur when meat is barbecued, and

its fat and juices fall upon the hot lava rock. Smoke of course helps give food its barbecued flavour, but it is best to avoid excessive flare-up to prevent food being burned. **To control flare-ups, it is ABSOLUTELY ESSENTIAL to trim away excess fat from meat and poultry before grilling, use cooking sauces and marinades sparingly and try to avoid very cheap cuts of meat or meat products as these tend to have a high fat and water content. Also, the burners should always be placed on the low setting during cooking.**

When flare-ups do occur, they can usually be extinguished by applying baking soda or salt directly onto the lava rock. Always protect your hands when handling anything near the cooking surface of the barbecue and take care to protect yourself from the flames.

If a fat fire occurs, please see the instructions given below.

Fat Fires

Empty and clean the grease cup of food debris after each cooking session. If the barbecue is to be used for large gatherings, it will be necessary to turn off and cool the barbecue every two hours to remove food debris from the grease cup and clean it out. The time between cleaning may need to be reduced if very fatty foods or cheap meat products are being cooked. Failure to do this may result in a fat fire, which may cause injury and could seriously damage the barbecue.

In the event of a fat fire:

- If safe to do so, turn all control knobs to the 'off' position.
- Turn off the gas supply at the gas bottle.
- Keep everyone at a safe distance from the barbecue and wait until the fire has burnt out.
- Do not close the hood or lid of the barbecue.
- NEVER DOUSE A BARBECUE WITH WATER. IF AN EXTINGUISHER IS USED, IT SHOULD BE A POWDER TYPE.
- DO NOT REMOVE THE GREASE CUP.
- If the fire does not seem to be abating or appears to be worsening, contact your local Fire Brigade for assistance.

End of Cooking Session

After each cooking session, keep the barbecue burners on the "low" position and burn for 5

minutes. This procedure will burn off cooking residue, thus making cleaning easier. Make sure the hood or lid is open during this process.

Turning Off Your Barbecue

When you have finished using your barbecue, turn all the control valves fully clockwise to the "Off" position, then switch off the gas supply at the bottle.

Wait until the barbecue is sufficiently cool before closing its hood or lid.

Care and Maintenance

Regularly clean your barbecue between uses and especially after extended periods of storage. Ensure the barbecue and its components are sufficiently cool before cleaning. Do not leave the barbecue exposed to outside weather conditions or stored in damp, moist areas.

- ▲ Never handle hot parts with unprotected hands.
- ▲ Never douse the barbecue with water when its surfaces are hot.

In order to extend the life and maintain the condition of your barbecue, we strongly recommend that the unit be covered when left outside for any length of time, especially during the winter months. Heavy-duty Outback® barbecue covers and other accessories are available from your local Outback® stockist.

Even when your barbecue is covered for its protection, it must be inspected on a regular basis as damp or condensation can form which may result in damage to the barbecue. It may be necessary to dry the barbecue and the inside of the cover. It is possible for mould to grow on any fat remaining on parts of the barbecue. This should be cleaned off smooth surfaces with hot soapy water.

Any rust that is found that does not come into contact with the food should be treated with a rust inhibitor and painted with barbecue paint or a heat resistant paint. Chrome plated warming racks etc. should be coated with cooking oil.

Cooking Surfaces & Warming Rack

When the barbecue has cooled, clean with hot soapy water. To remove any food residue, use a mild cream cleaner on a non-abrasive pad.

Do not use scouring pads or powders as they can permanently damage the finish. Rinse well and dry thoroughly. Due to the weight of the cooking surfaces, we do not recommend cleaning in a dishwasher.

Burner

Your burner has been preset for optimal flame performance. You will normally see a blue flame, possibly with a small yellow tip when the burner is alight. If the flame pattern is significantly yellow, this could be a problem caused by grease from cooking blocking the burner, or debris or insects in the burner portholes or venturi tubes. This can result in the flow of the gas and air mixture being restricted or blocked which may result in a fire behind the control panel causing serious damage to your barbecue. **If this happens, and if safe to do so, the gas should be immediately turned off at the bottle.**

Burner should be inspected, removed and cleaned on a regular basis, at least annually, in addition to the following conditions:

- 1) Bringing the barbecue out of storage.
- 2) One or more of the burners do not ignite.
- 3) The burner flame pattern is significantly yellow.
- 4) The gas ignites behind the control panel.
- 5) When heavy build up is found.

Provided that they are operating correctly, in normal usage, burning off the residue after cooking will keep the burners clean.

To clean a burner fully, remove it from the barbecue. A soft wire brush can be used to remove corrosion from the burner surfaces. Use a pipe cleaner or piece of wire to clear obstructions in the burner portholes and venturi tubes, taking care not to enlarge the portholes.

Clean the insect screen on the end of the venturi tube with a bristle brush (i.e. an old toothbrush).

You may need a torch to see into the venturi tube to make sure it is clear. Turn the burner up on end and lightly tap against a hard surface like a piece of wood, to dislodge any debris from inside.

When refitting the burner, be careful to check that the venturi tubes of the burner fit over the valve outlets.

Lava Rock

It is not necessary to remove and wash the lava rock in order to keep it clean. With the hood opened burning off the residue for 3 to 5 minutes after each cooking session should be sufficient. Heavily impregnated lava rock should be turned over so that the dirty side faces the burners in order to burn off any residue. Replacement lava rock is available from your local Outback® stockist.

Grease Cup

After every use, empty and clean the grease cup of any fat or food particles, using a plastic or wooden scraper if necessary.

Failure to keep it clean, and excessive build up can result in a fat fire. This can be hazardous and severely damage the barbecue. **This is not a fault in the barbecue and is therefore not covered by the terms of the warranty.** If required, the cup can be washed in hot soapy water.

Barbecue Body

Regularly remove excess grease or fat from the barbecue body using a cloth wrung out in hot soapy water and dry thoroughly. Excess fat and food debris can be removed from inside the body using a soft plastic or wooden scraper. It is not necessary to remove all the grease from the body. If you need to clean fully, use hot soapy water and a cloth, or nylon-bristled brush only. Do not use abrasives. Remove cooking surfaces and burners before full cleaning. Do not immerse the gas controls or manifold in water. Check burner operation after carefully refitting into body.

Barbecue Hood or Lid & Trolley

Use a non-abrasive cloth or pad and clean with hot, soapy water. Do not use scouring pads or powders as they can permanently damage the finish.

Fixings

All screws and bolts, etc. should be checked and tightened on a regular basis.

Storage

Ensure the barbecue is properly cooled before covering or storing. Store your barbecue in a cool dry place.

Cover the burners with aluminium foil in order to prevent insects or other debris from

collecting in burner holes.

If the barbecue is to be stored indoors, the gas bottle must be disconnected and left outside. The gas bottle should always be stored outside, in a dry, well-ventilated area, away from any sources of heat or ignition. Do not let children tamper with the bottle.

When using the barbecue after extended periods of storage follow the cleaning procedures.

Technical Specifications

	CE Approval	Heat Input	Burners	Injector Size	Gas /Pressure
Outback® Excel 200 Gas	0359 359BS791	6.6kW	1	0.89mm	28-30 mbar Butane or 37 mbar Propane
Outback® Excel 300 Gas	0359 359BS791	6.6kW	1	0.89mm	28-30 mbar Butane or 37 mbar Propane
Side Burner	359 359BS791	2.3kW	1	0.74mm	28-30 mbar Butane or 37 mbar Propane

Gas Consumption:
Excel 200 Gas: 472g/hr
Excel 300 Gas: 472g/hr
Side Burner: 165g/hr

Countries of Use:
I₃₊ (28-30/37) BE, CH, CY, CZ, ES, FR, GB, GR, IE, IT, LT, LU, LV, PT,
SK, SI

Specifications subject to change without prior notice.

Notes:

Troubleshooting

Problem	Possible Cause	Solution
Burner will not light using the ignition system	LP gas bottle is empty	Replace with full bottle
	Faulty regulator	Have regulator checked or replaced
	Obstructions in burner	Clean burner
	Obstructions in gas jets or gas hose	Clean jets and gas hose
	Electrode or ignition button wire is loose or disconnected on electrode or ignition unit	Reconnect wire
	Electrode or wire is damaged	Change electrode and wire
	Faulty ignition button	Change ignitor and / or button
Burner will not light with a match	LP gas bottle is empty	Replace with full bottle
	Faulty regulator	Have regulator checked or replaced
	Obstructions in burner	Clean burner
	Obstructions in gas jets or gas hose	Clean jets and gas hose
Low flame or flashback (fire in burner tube— a hissing or roaring noise may be heard)	LP gas bottle too small	Use larger bottle
	Obstructions in burner	Clean burner
	Obstructions in gas jets or gas hose	Clean jets and gas hose
	Windy conditions	Use barbecue in a more sheltered position
Gas valve knob difficult to turn	Gas valve jammed	Replace gas valve

Manufacturer:
 TPA Industrial (DG) Co. Ltd.
 Xingguang Rd., Huangjiang, Dongguan
 Guangdong, China 523768

OUTBACK® WARRANTY

OUTBACK® barbecues are warranted to the original purchaser against defects in materials and workmanship. OUTBACK® will supply replacements for defective parts free of charge provided that:

- ◆ The product has not been used for trade, professional or hire purposes.
- ◆ The product has not been subjected to misuse or neglect, including fat fires and flare ups or use of a faulty or incorrect regulator.
- ◆ The product has not sustained damage through foreign objects, substances or accidents.
- ◆ The care and maintenance instructions given in your OUTBACK® manual have been followed.

Any warranty and guarantee claims shall be rendered void in the event of improper use of the barbecue or the use of non-approved fuels. Discolouration, rusting or slight deformation of parts exposed directly to the flames (grill, griddle, flame tamer, burner, etc.) do not impair the function of the barbecue and do not form a basis for any claims.

This warranty is offered as an extra benefit and is in addition to the customers' statutory rights.

OUTBACK® does not in any way warranty the gas cylinder.

In the unlikely event that you experience problems with this barbecue, please fill in our warranty form at:

<http://www.outbackbarbecues.com/warranty-form>

One of our colleagues will be in contact with you shortly.

For reference and correspondence, record your serial number here.
(See sticker on side of barbecue body.)

Serial No. _____

This number may be required when ordering spare parts or accessories. A part reference number may also be required where applicable.

HELPLINE NUMBER: 0345 388 6032